

**CATALOGUE
FLEXCLEAN®**

- » FlexClean flushing trays
- » Connectors
- » Accessories

INTRODUCTION

The FlexClean system is an innovative way to flush hollow instruments in a washing machine.

Advantages of the FlexClean system:

- Flush hollow instruments.
- Time efficient.
- Use your standard washing rack.



The portfolio consists of trays with flushing tubes, modular flushing tubes, connections, tubing and other accessories to flush instruments in the Central Sterile Services Department (CSSD).

After installation of a FlexClean connector into the mobile washing rack, numerous options are available to arrange one or several FlexClean trays using various connections.

CONNECTORS FOR FLUSH TUBE AND SILICONE TUBING

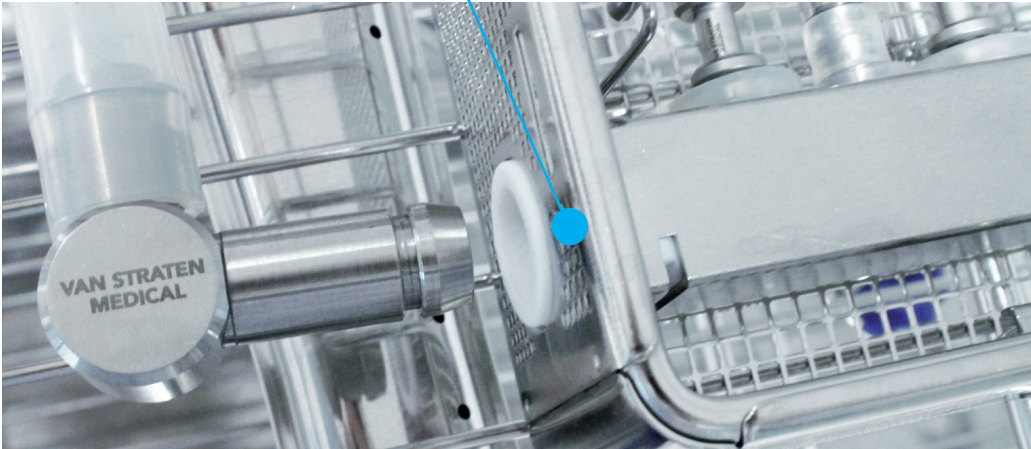
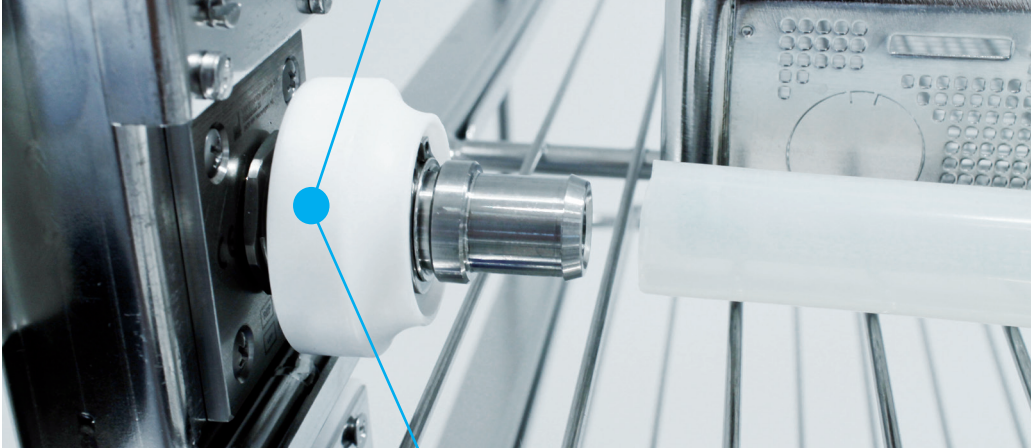
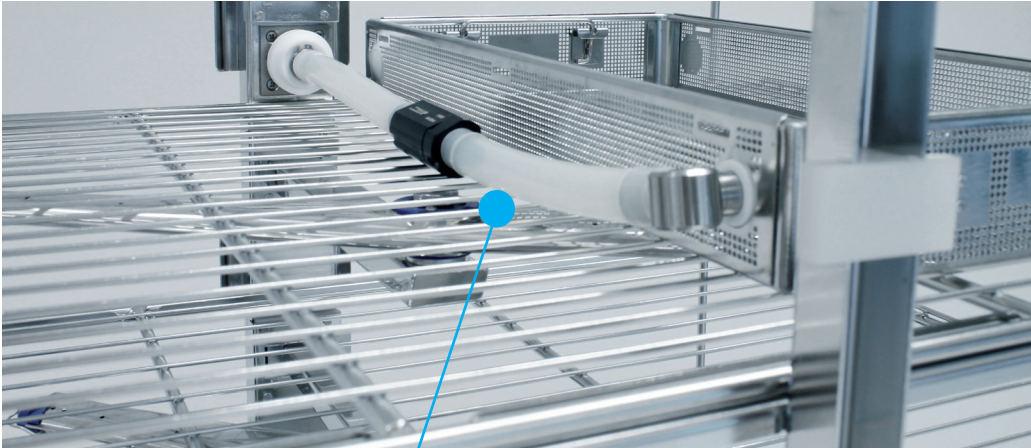

EXAMPLES OF FLUSHING TRAYS

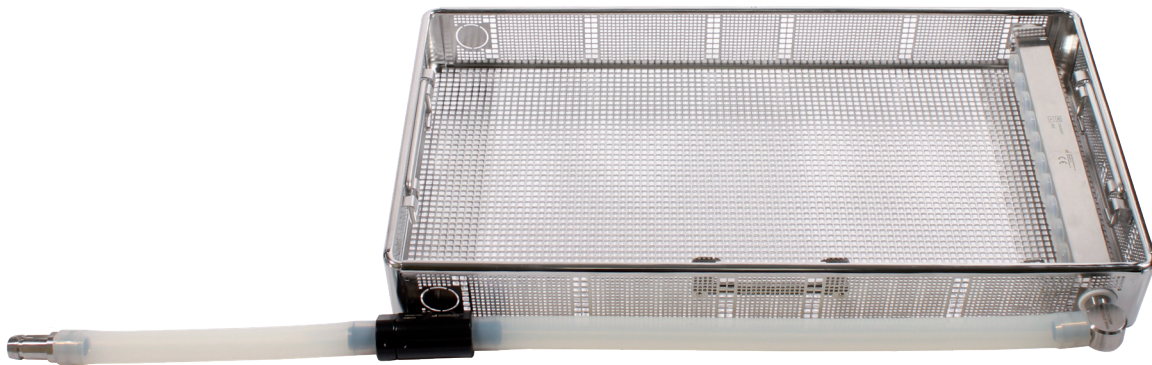

Set for hollow instruments - 10 openings

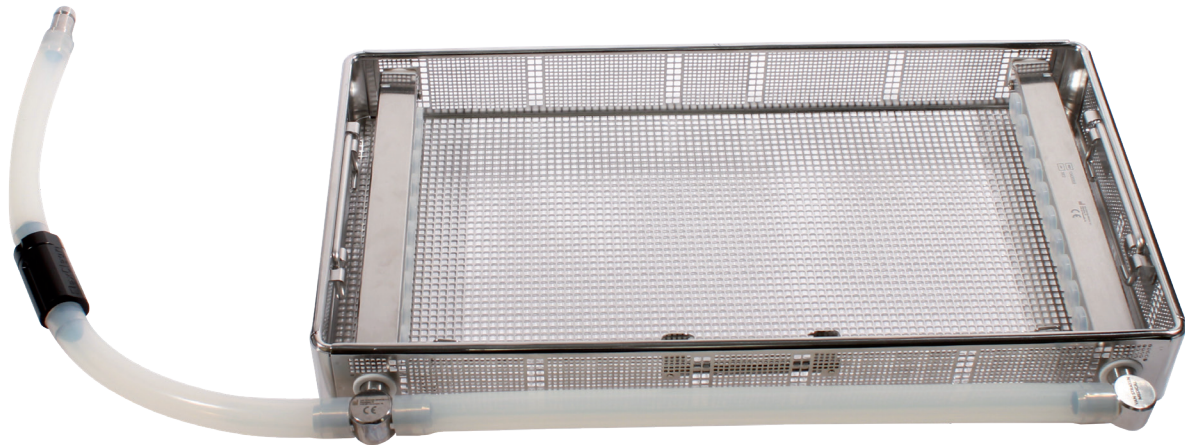

Set for hollow instruments - 20 openings



Set for dental handpieces – 7 connections

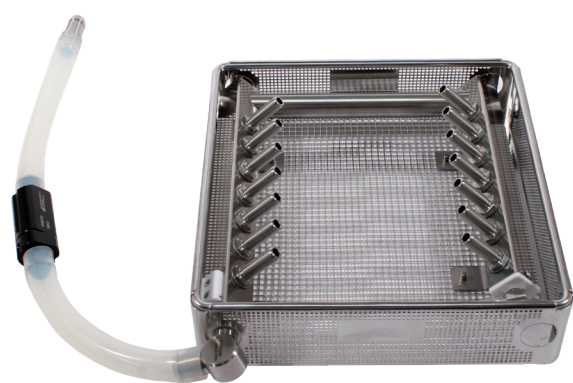

Set for dental handpieces – 14 connections

CATALOGUE

A variety of FlexClean products provide you the flexibility to configure your preferred kit and is an ideal option for both first time users and those already using FlexClean.

Flushing trays

Page 6-8

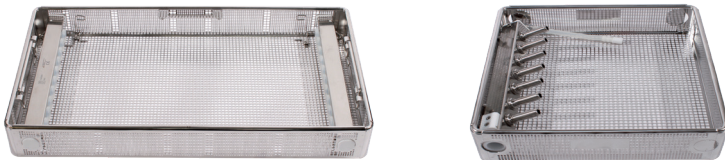

Connections, filters and silicone tubing

Page 9



Modular flushing tubes

Page 10



Connectors

Page 11



Flush tube spare parts and accessories

Page 12-13



Injector jets, sleeves and caps

Page 14-15



DIN TRAYS WITH FLUSHING TUBE

Article nr	Dimensions Tray (mm)	Description
13420201	480 x 250 x 60 Flush entrance right (R)	Tray with 1 x flushing tube, 10 openings on short side. 
13420201L	480 x 250 x 60 Flush entrance left (L)	
13420209	510 x 250 x 60 Flush entrance right (R)	
13420209L	510 x 250 x 60 Flush entrance left (L)	

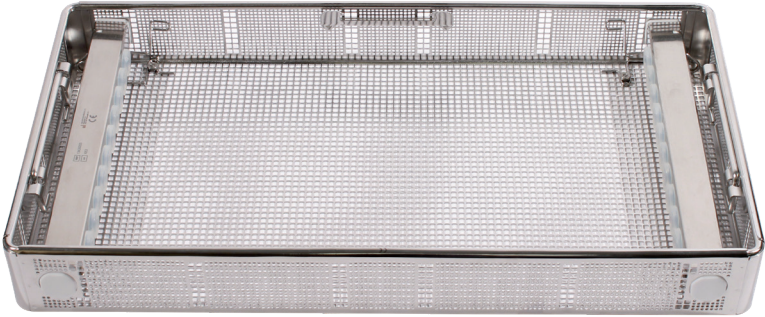
Article nr	Dimensions Tray (mm)	Description
13420203	480 x 250 x 60	Tray with 2 x flushing tube with 20 (2 x 10) openings situated on short sides 
13420205	510 x 250 x 60	
13420206	650 x 250 x 60	

DENTAL TRAY WITH FLUSHING TUBE

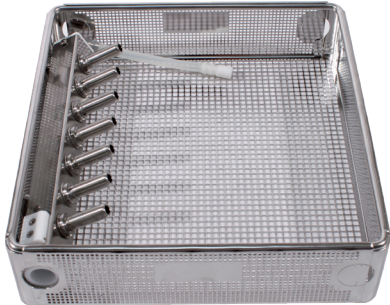
Article nr	Dimensions Tray (mm)	Type Fitting	Description
13420603	240 x 250 x 60	INTRA (slow speed)	Dental tray with flushing tube in 30° angle - 7 connections 

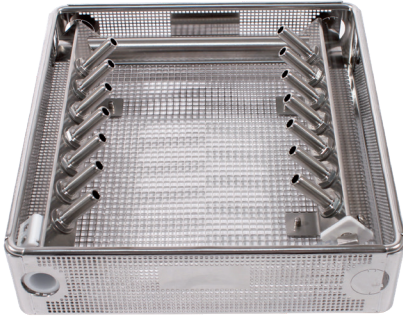
Article nr	Dimensions Tray (mm)	Type Fitting	Description
13420604	240 x 250 x 60	INTRA (slow speed)	Dental tray with U-flushing system in 45° angle - 14 connections 

Article nr	Type fitting	Description
134600101	INTRA (slow speed)	Closure cap to close the openings in the dental washing tube that are not being used. 

MICROWASH TRAY WITH MODULAR FLUSHING TUBE

Article nr	Dimensions Tray (mm)	Description
240250040	240 x 250 x 40	<p>Ophthalmology tray, with pre-perforated holes (ready for placing a modular flushing tube)</p> 
340250040	340 x 250 x 40	
440250040	440 x 250 x 40	
13420134	3 ports	<p>Modular flushing tubes with hanging strip to place manually in a 40 mm height tray.</p> 
13420137	5 ports	

CONNECTION TO WASHING RACK OR MANIFOLD

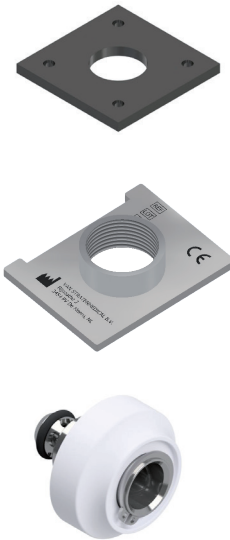
Article nr	Description	
13420150	Stainless steel plate, incl 4 screws for connection to mobile washing rack or trolley	
13420155	Stainless steel plate for connection in Geringe mobile washing rack	
13420125	Washing connector for mobile washing rack or trolley	

FILTER SYSTEM



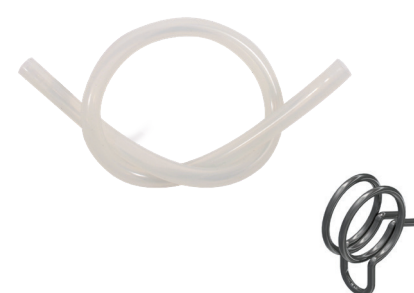

Article nr	Description	
13420180	Filter housing to hold disposable filter.	
1342018040	Disposables filters, packed per 25	

SILICONE TUBING Ø 21 MM

Article nr	Description	
13420121	Silicone Tubing, inner diameter x outer diameter: 15 mm x 21 mm. Packed per meter	
13420117	Stainless steel tube clamp, to fasten the silicone tubing with stainless steel connectors and/or filter house	

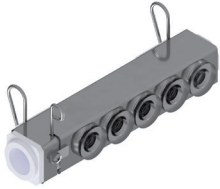





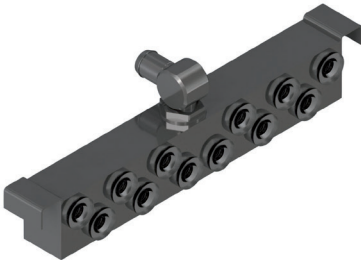





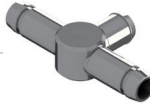

MODULAR FLUSHING TUBES

Flushing tubes with hanging strip to place manually in a 40 or 60 mm height tray

Article nr	Number of ports	Description	
13420133	3	60 mm height	
13420134	3	40 mm height	
13420136	5	60 mm height	
13420137	5	40 mm height	
13420139	10	60 mm height	
13420138	10	40 mm height	

Article nr	Number of ports	Description	
13410068	12	60 mm height	Flushing tube with hanging strip for a 60 mm standard DIN basket 

CONNECTORS FOR FLUSH TUBE AND SILICONE TUBING

Article nr	Type	Description	
13420124	Straight	1 flush tube connection 1 silicone connection	
13420129	L-connector	1 flush tube connection 1 silicone connection	
13420123	L connector to 10 cm tube	1 flush tube connection 1 silicone connection	
13420149	L-connector	2 silicone connections	
13420128	T-connector	1 flush tube connection 2 silicone connections	
13420130	T-connector	3 silicone connections	
13420140	T-connector, 4 cm width	2 flush tube connections 1 silicone connection	
13420141	T-connector, 4 cm width	1 flush tube connection 2 silicone connections	
13420143	T-connector 6 cm width	2 flush tube connections 1 silicone connections	
13420142	Cross-connector, 4 cm width	2 flush tube connections 2 silicone connections	
13420146	Cross-connector, 6 cm width	2 flush tube connections 2 silicone connections	
13420144	Cross-connector, 6 cm width	3 flush tube connections 1 silicone connections	
13420132	Cross connector	4 silicone connection	
13420131	Y-connector	1 flush tube connection 2 silicone connections	
13420145	Z-connector	1 flush tube connection 1 silicone connection	

FLUSH TUBE SPARE PARTS

Article nr	Description	
13420100	Spare part silicone plug to be placed into flushing tube, per 10 pieces	
13420101	Stainless steel stop, to close the openings of the flushing tube, which are not use	

SPARE CONNECTORS, LUERS AND PLUGS

For silicone tube (ID 5 mm x OD 8 mm), flushing tube and instruments





Article nr	Description	
13420104	Plug for silicone tube and flushing tube	
13420106	Connector Luer Lock male	
13420107	Connector Luer Lock female	
13420400	Connector 90° angle	
13420401	Connector straight	
13420402	Connector Luer Lock female 90° angle	
13420126	Y connector	
13410067	Davinci Xi	
13410070	Davinci S	

SILICONE TUBING Ø 8 MM









Article nr	Description	
13420030	Silicone Tubing, inner diameter x outer diameter: 5 mm x 8 mm, length 30 cm	
13420050	Silicone Tubing, inner diameter x outer diameter: 5 mm x 8 mm, length 50 cm	
13420102	Silicone Tubing, inner diameter x outer diameter: 5 mm x 8 mm, length per meter	

SILICONE TUBING Ø 8 MM WITH CONNECTORS, LUERS AND PLUGS

Spare connectors and plugs with silicone tube ID 5 mm x OD 8 mm, length 30 cm, to connect with flushing tube and instruments

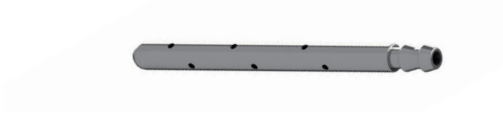
Article nr	Type	Description
13420098	Connector Luer Lock female 90° angle	
13420103	Connector Luer Lock female	
13420105	Connector 90° angle	
13420114	Connector straight	
13420118	Connector Luer Lock male	

INJECTOR JETS FOR HOLLOW INSTRUMENTS

Article nr	Diameter	Length	Description
13420109	Ø 2,5 mm	77 mm	
13420111	Ø 4 mm	95 mm	
13420111M	Ø 4 mm	95 mm screw connection M8	
13420111L	Ø 4 mm	160 mm	
13420081	Ø 8 mm	90 mm	
13420110	Ø 8 mm	150 mm	
13420110L	Ø 8 mm extra perfora- ted holes	150 mm	
13420110M	Ø 8 mm	150 mm screw connection M8	

INJECTOR SLEEVES

Article nr	Length	Description	
134210121	120 mm	To place instruments into the sleeve	
134210401	40 mm	To place instruments into the sleeve	

SILICONE CAPS FOR INJECTOR SLEEVES

Packed per 10 pieces

Article nr	Type	Description
1342105110	Ø 1 mm	
1342105610	Ø 6 mm	
1342106010	Ø 10 mm	
1342106510	Cross cut	

OUR MISSION



Providing value to life
by bringing medical innovations to the world.

Innovation is the core activity of Van Straten Medical and it is our policy to use innovation in such a way that a positive contribution is provided to healthcare. We seek to develop and provide innovative products and services with premium quality to our customers. Our focus is to become the most versatile manufacturer, including repair, of surgical instruments and to be a global supplier of surgical products.

Your distributor

vanstratenmedical.com

Rijnzathe 2, 3454 PV De Meern, The Netherlands - T: +31 (0)30 602 38 30 - E: export@vanstratenmedical.com