

GO BASKET

Product portfolio instrument baskets

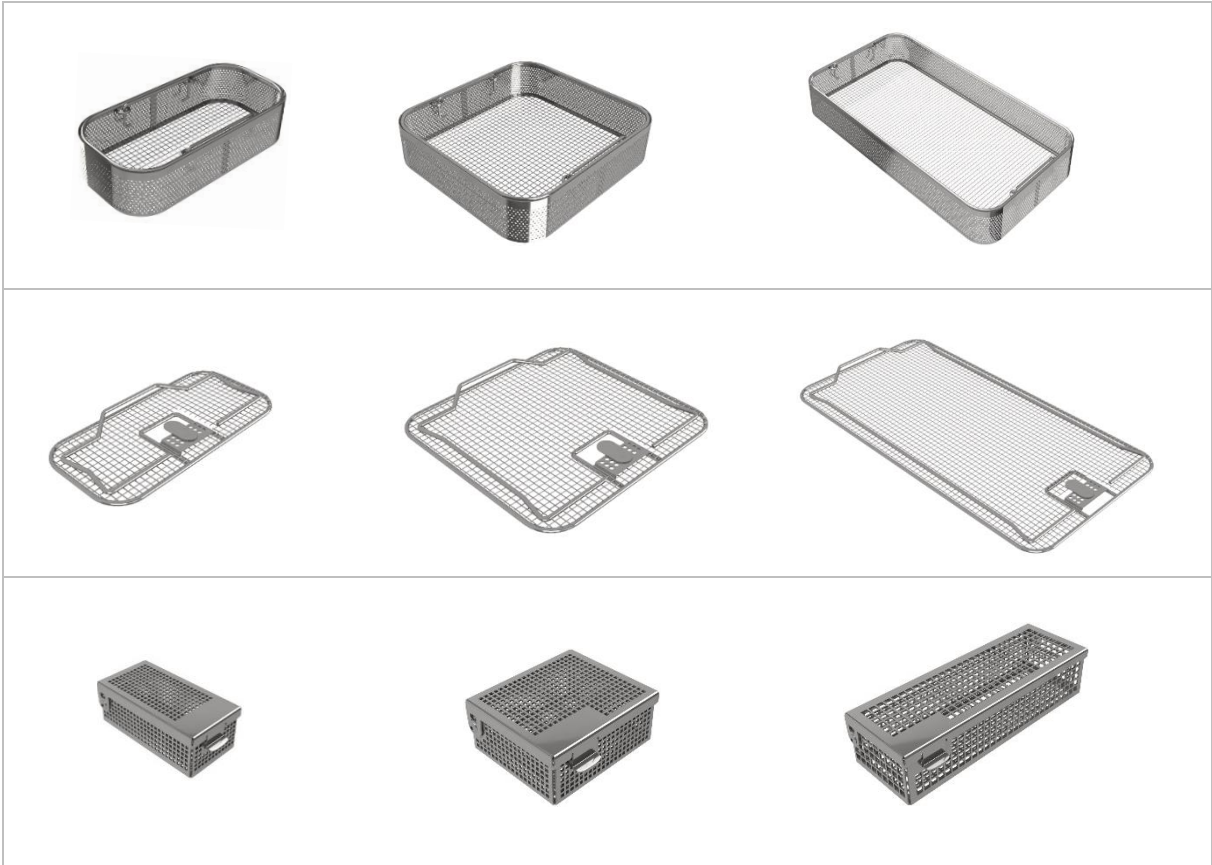

Table of contents

GO BASKET – MESH BASKETS3

GO BASKET – MINI BASKETS OR TRINKET BASKETS6

Company information and sustainable GO Product portfolio

Van Straten Medical is a family-owned company founded in 1975. We are specialised in surgical instrument repairs, manufacturing customized instrument baskets and flushing devices for the cleaning of hollow instruments.

Our vision is that sustainable solutions will change healthcare, contributing to a circular economy. In a circular economy products are reused, repaired, refurbished and recycled as long as possible to create more value and less waste.



Our mission is to extend the lifespan of medical devices, maintain patient’s safety and introduce new circular products with our **‘GO’ product portfolio** such as the GO BASKET and GO JACK, an instrument opener used as a ‘jack’ to keep hinged instruments open during the automated cleaning process.

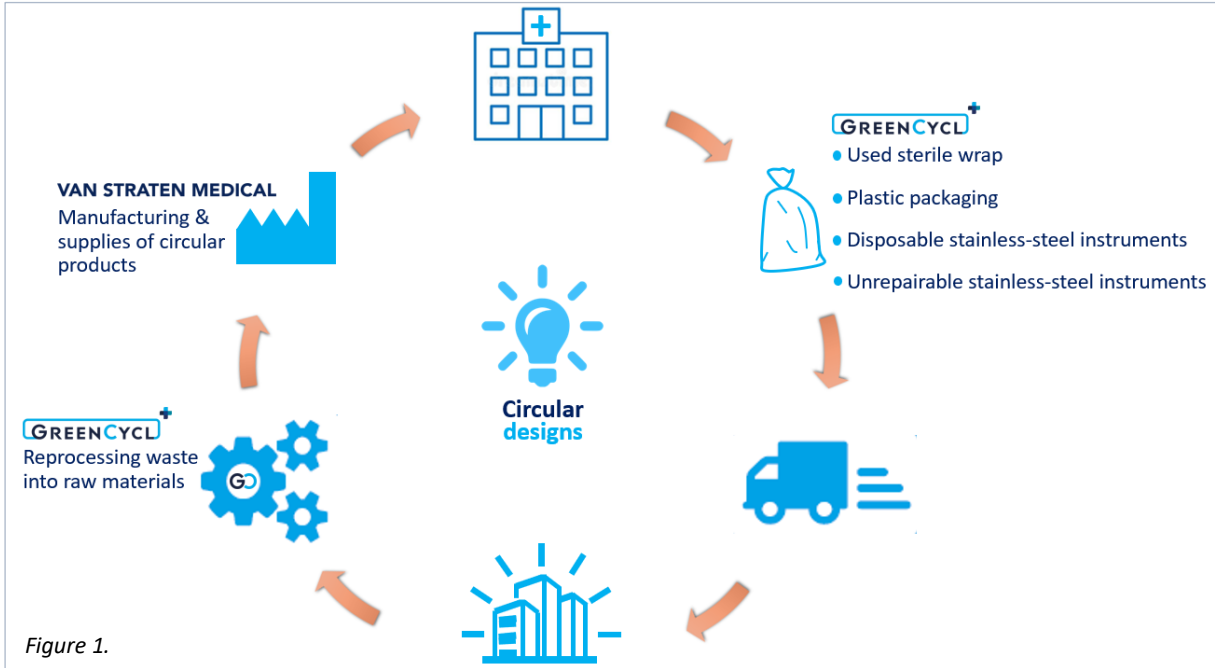

GO products are made of recycled sterile wrap (polypropylene) or recycled stainless steel. These are fully recyclable materials with high recycle value.



In 2019, GreenCycl was co-founded by Van Straten Medical, which is committed to make healthcare more sustainable. GreenCycl collects and reprocesses hospital waste into new raw materials. Van Straten Medical sources these raw materials and produces new medical class I low risks products (see figure 1).





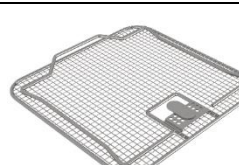



GO BASKET – MESH BASKETS

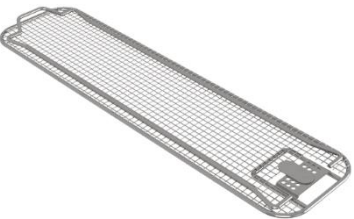

Description			Art. No.
	120 x 250 x 60 mm wire mesh basket with handles	6 x 6 mm mesh 2 mm side perforation	002-120250060MH
	120 x 250 x 60 mm wire mesh basket without handles	6 x 6 mm mesh 2 mm side perforation	002-120250060ZH
	120 x 250 mm lid with closure lock	6 x 6 mm mesh	002-120250

Description			Art. No.
	240 x 250 x 40 mm wire mesh basket with handles	6 x 6 mm mesh 2 mm side perforation	002-240250040
	240 x 250 x 60 mm wire mesh basket with handles	6 x 6 mm mesh 2 mm side perforation	002-240250060
	240 x 250 x 100 mm wire mesh basket with handles	6 x 6 mm mesh 2 mm side perforation	002-240250100
	240 x 250 mm lid with closure lock	6 x 6 mm mesh	002-240250







Description			Art. No.
	360 x 250 x 60 mm wire mesh basket with handles	6 x 6 mm mesh 2 mm side perforation	002-360250060
	360 x 250 mm lid with closure lock	6 x 6 mm mesh	002-360250



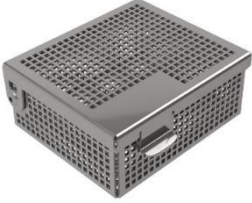

Description			Art. No.
	480 x 125 x 60 mm wire mesh basket with handles	6 x 6 mm mesh 2 mm side perforation	002-480125060
	480 x 125 mm lid with closure lock	6 x 6 mm mesh	002-480125

Description			Art. No.
	480 x 250 x 40 mm wire mesh basket with handles	6 x 6 mm mesh 2 mm side perforation	002-480250040
	480 x 250 x 60 mm wire mesh basket with handles	6 x 6 mm mesh 2 mm side perforation	002-480250060
	480 x 250 x 80 mm wire mesh basket with handles	6 x 6 mm mesh 2 mm side perforation	002-480250080
	480 x 250 x 100 mm wire mesh basket with handles	6 x 6 mm mesh 2 mm side perforation	002-480250100
	480 x 250 x 120 mm wire mesh basket with handles	6 x 6 mm mesh 2 mm side perforation	002-480250120
	480 x 250 mm, lid with closure lock	6 x 6 mm mesh	002-480250

Description			Art. No.
	540 x 250 x 60 mm wire mesh basket with handles	6 x 6 mm mesh 2 mm side perforation	002-540250060
	540 x 250 mm lid with closure lock	6 x 6 mm mesh	002-540250

GO BASKET – MINI BASKETS OR TRINKET BASKETS

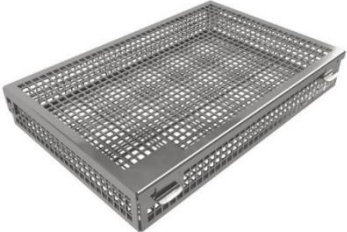
Description			Art. No.
	70 x 60 x 30 mm perforated basket with lid	2 x 2 mm perforated mesh	706030-2
	80 x 40 x 25 mm perforated basket with lid	2 x 2 mm perforated mesh	804025-2
	80 x 40 x 30 mm perforated basket with lid	2 x 2 mm perforated mesh	804030-2
	80 x 80 x 40 mm perforated basket with lid	2 x 2 mm perforated mesh	808040-2
	140 x 60 x 30 mm perforated basket with lid	4 x 4 mm perforated mesh	1406030-4
	150 x 50 x 35 mm perforated basket with lid	4 x 4 mm perforated mesh	1505035-4

Description			Art. No.
	170 x 60 x 30 mm perforated basket with lid	4 x 4 mm perforated mesh	1706030-4
	190 x 85 x 30 mm perforated basket with lid	2 x 2 mm perforated mesh	1908530-4
	190 x 125 x 30 mm perforated basket with lid	2 x 2 mm perforated mesh	19012530-4
	200 x 100 x 35 mm perforated basket with lid	2 x 2 mm perforated mesh	20010035-4

OUR STORY



VAN STRATEN MEDICAL is a family-owned company founded in 1975. We specialize in repair of surgical instruments, production of tailor-made instrument sets, flushing systems and CSSD accessories.

Our vision is that sustainable solutions will change healthcare, contributing to a circular economy. In a circular economy products are reused, repaired, refurbished and recycled as long as possible to create more value and less waste.

Our mission is to extend the lifespan of medical devices, maintain patient's safety, introduce new technical solutions and make our products circular with our 'GO' product portfolio.

Your distributor

[vanstratenmedical.com](https://www.vanstratenmedical.com)

Rijnzathe 2, 3454 PV De Meern, The Netherlands - T: +31 (0)30 602 38 30 - E: export@vanstratenmedical.com